

ASSEMBLY INSTRUCTIONS

Conversion Kit

BAILEY

Model # 8370

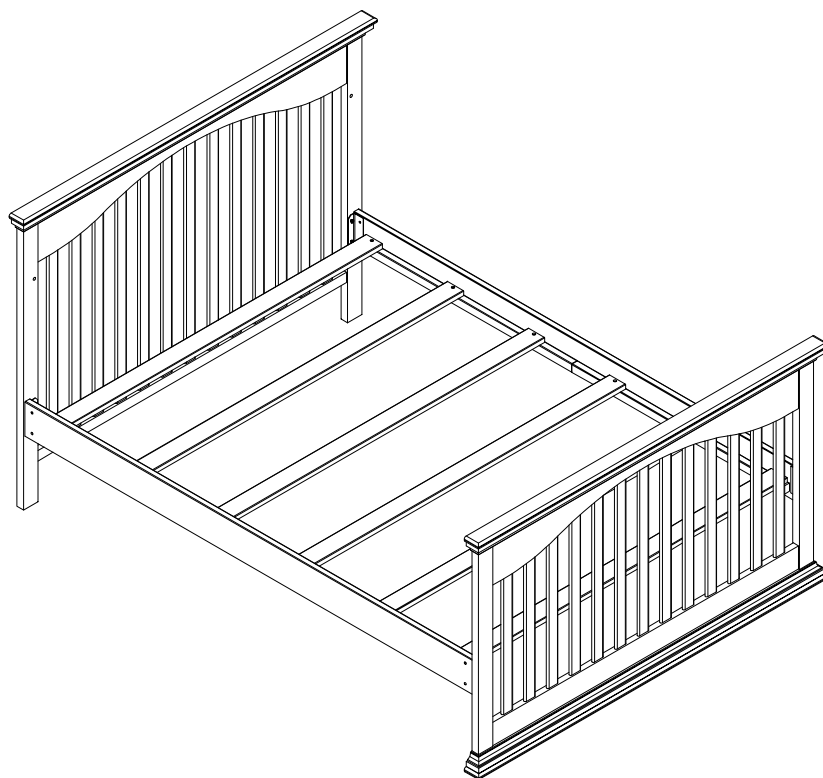

" RECOMMENDATION: We recommend the use of a Bunkie Board or box spring under a mattress for this conversion kit."

Carefully remove and lay out all parts. Familiarize yourself with all exhibits and diagrams to facilitate the assembly of your crib

TOOLS REQUIRED :

Allenkey (supplied)

Screw Driver (Unsupplied)

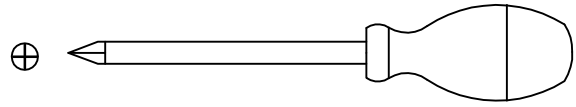
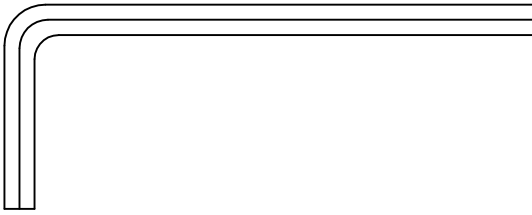

PART ENCLOSED IN CARTON

A. Rails (2 pcs)



B. Slat (6 pcs)

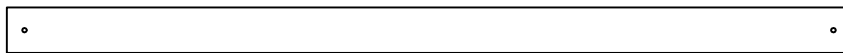

HARDWARE

C. Allenbolt 1" (25 mm) (4 pcs)



G. Screw 1 1/4" (30 mm) (12 pcs)

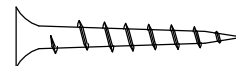

D. Allenbolt 5/8" (15 mm) (4 pcs)

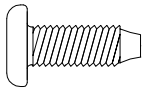

L. Nut 3/4" (20 mm) (6 pcs)

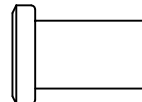

W. Spring Washer (8 pcs)

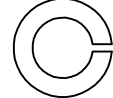

P. Allenbolt 3/4" (20 mm) (2 pcs)

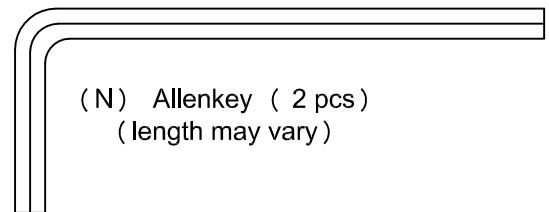
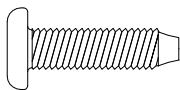

(N) Allenkey (2 pcs)
(length may vary)

Make sure the bolts are tightly locked against the washers during assembly.
(Please add an extra 1/2 revolution to all the bolts when using spring washer after tightening)

STEP 1 " ASSEMBLY OF HEAD BOARD "

THIS STEP REQUIRES :

Headboard (1 pc)

A. Rails (2 pcs)

N. Allenkey (2 pcs)

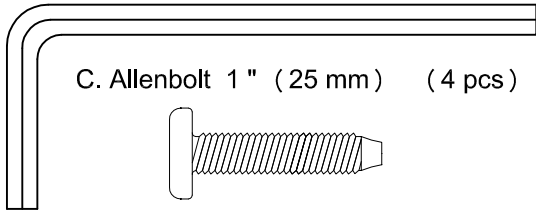

C. Allenbolt 1 " (25 mm) (4 pcs)

W. Spring Washer (4 pcs) L. Nut 3/4" (20 mm) (4 pcs)

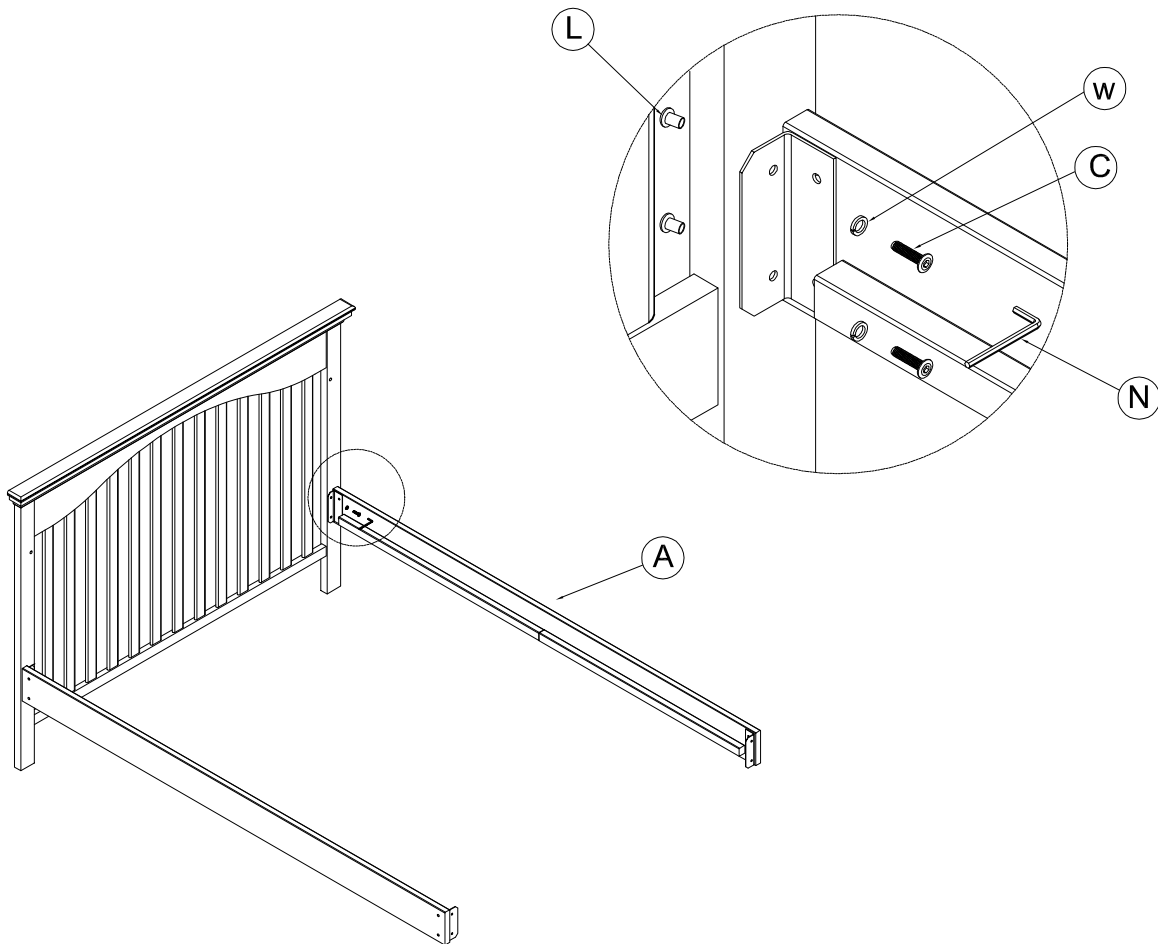
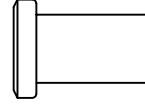
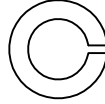

- Insert Allenbolt 1 " (25 mm) (C) with spring washer (W) through the metal bracket holes in the end of side rail through the top & bottom holes in headboard and connect with nut 3/4" (20 mm) (L) .
Hand tighten only

STEP 2 " ASSEMBLY OF FOOTBOARD "

THIS STEP REQUIRES :

Footboard (1 pc)

N. Allenkey (2 pcs)

L. Nut 3/4" (20 mm) (2 pcs)

W. Spring Washer (4 pcs)

D. Allenbolt 5/8" (15 mm) (4 pcs)

P. Allenbolt 3/4" (20 mm) (2 pcs)

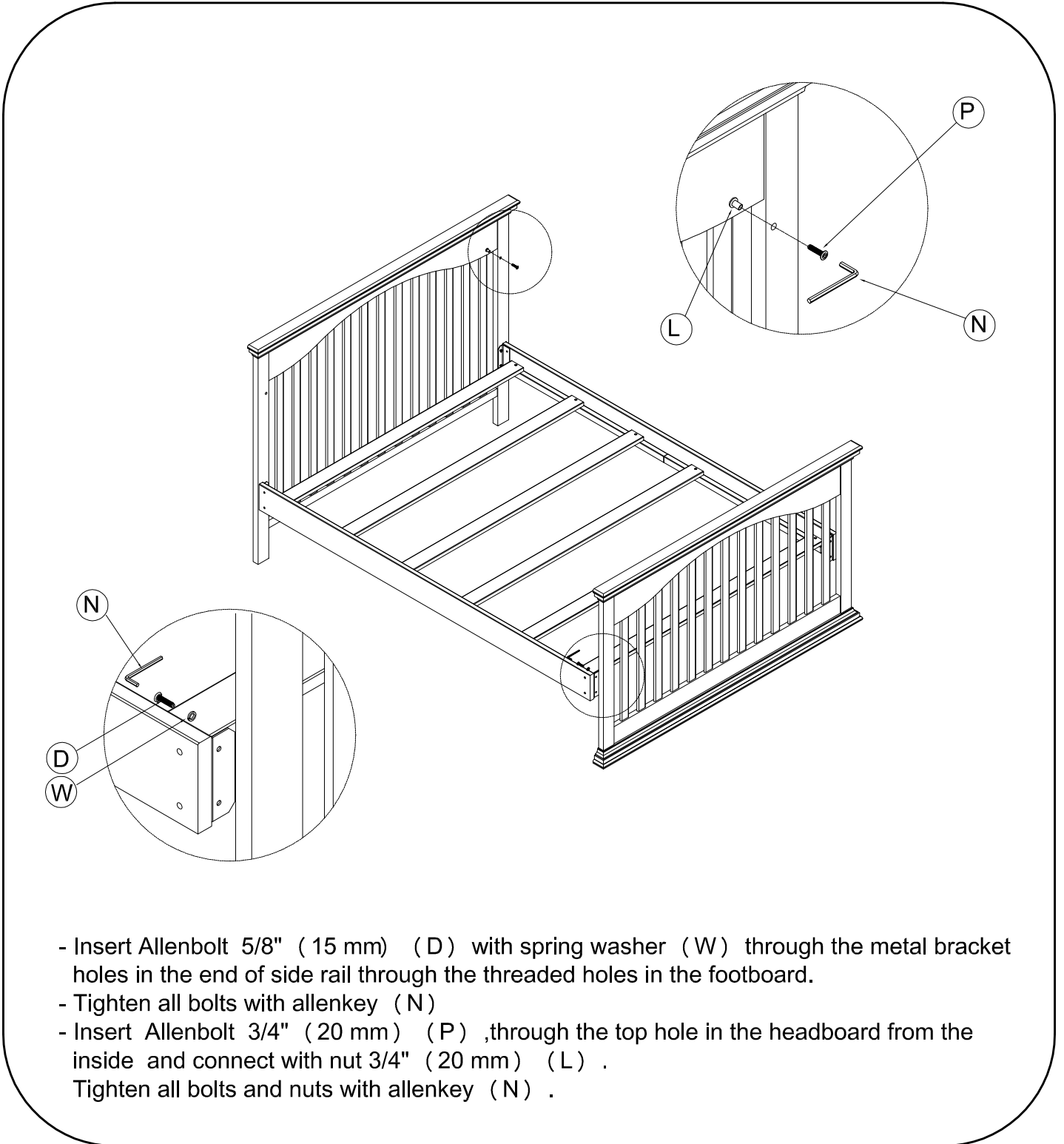
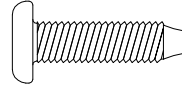
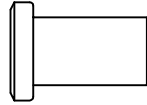
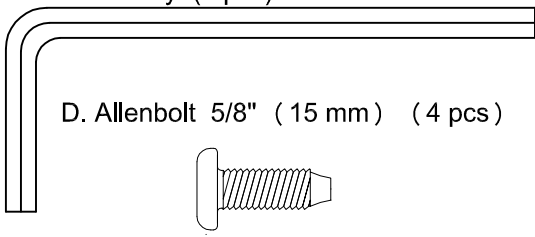
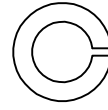

- Insert Allenbolt 5/8" (15 mm) (D) with spring washer (W) through the metal bracket holes in the end of side rail through the threaded holes in the footboard.
- Tighten all bolts with allenkey (N)
- Insert Allenbolt 3/4" (20 mm) (P) ,through the top hole in the headboard from the inside and connect with nut 3/4" (20 mm) (L) .
Tighten all bolts and nuts with allenkey (N) .

STEP 3 " ASSEMBLY OF SLATS "

THIS STEP REQUIRES :

B. Slats (6 pcs)

G. Screw 1 1/4 " (30 mm) (12 pcs)

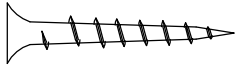

Screw Driver
(Unsupplied)

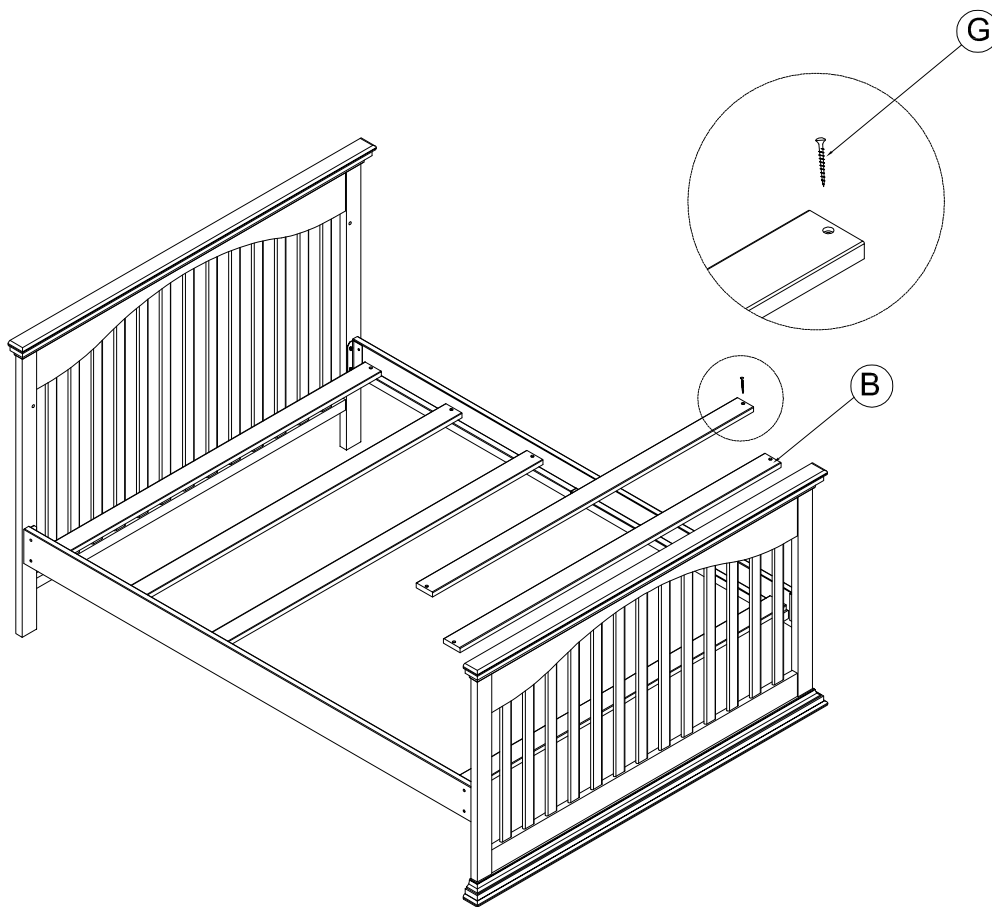
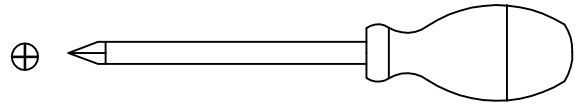

- Install 6 pcs of slats (B) to the 2 pcs of side rail above the pre drilling holes.
- Insert 12 pcs of screw 1 1/4 " (30 mm) (G) screws into the slats holes through side rail pre drilling holes. Hand tighten only.
- After all 12 pcs of screw inserted, fasten with screw driver.